

# 60mm Din Rail Heat Sink and Solid State Relay

## Installation

1) Mount heat sink on din rail capable of supporting the full weight of the heat sink. Take into account any additional stress that may be placed on the din rail by the wiring harness.

2) If din rail can not fully support the weight of the heat sink, a hole is provided on the din rail bracket for a support screw.

3) Insure that the panel containing the heat sinks is properly ventilated to allow adequate air flow. Forced air into and out of the panel is strongly recommended. Excessive temperatures will decrease the life of the solid state relay.

4) Mount heat sinks with the fans on the bottom so that air is forced up through the fins.

5) Allow for adequate spacing between heat sinks. 45mm between heat sinks without fans and 30mm between heat sinks with fan assemblies is recommended for maximum ratings.

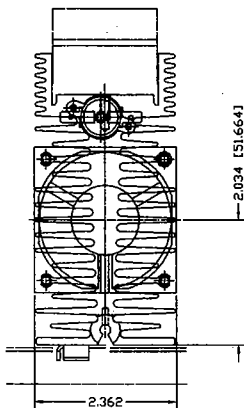

## HS-12

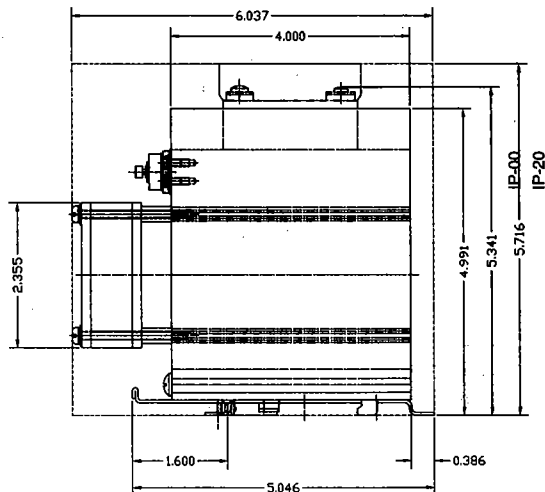

(Relay Optional)

## General Information

1) On the HS-12 Heat Sink, -75 & -100 solid state relays, a thermal cutout is mounted above the fan assembly on the side of the heat sink and factory wired to the +A1 terminal of the solid state relay. Connect the DC common or AC neutral line of the control supply directly to terminal 4/A2 of the SSR, and connect the + DC or AC line of the control supply to the 3/16" fast-on terminal on the thermal cutout. **DO NOT BYPASS THERMAL CUTOUT. FAILURE TO PROPERLY WIRE THE CONTROL SIGNAL OF THE SSR MAY RESULT IN DAMAGE TO THE RELAY AND/OR LOAD.**

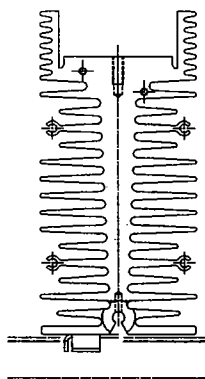

## HS-10

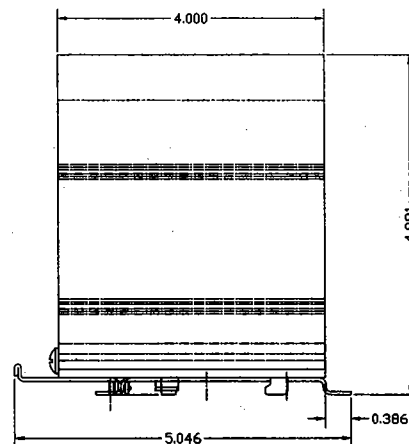

2) Do not relocate thermal cutout. The thermal cutout may not detect over temperature conditions if it is repositioned. **THE THERMAL CUTOUT IS ONLY A SAFETY FEATURE AND DOES NOT GUARANTEE FAILSAFE OPERATION OF THE SSR.**

3) The life of the -75/-100 SSR is dependent upon the operation of the fan. Failure to use fan during normal operation, or continual use of the relay if fan fails, may lead to thermal damage to the SSR. If the thermal cutout actuates due to fan failure, replace the fan and reset the thermal cutout by pressing the button located on top of the cutout.

Contact the factory if thermal cutout actuates during normal operation.

4) The output terminals (1/L1, 2/T1) of the 84 137 series IP20 SSR will accept solid or stranded wires up to #8 AWG without requiring ring or fork terminals. However, it is recommended that ring or fork terminals be used in applications where the steady state current exceeds 50 amps rms.

Products and specifications subject to change without notice.  
Consult factory for application assistance.

## General Specifications:

### Output

	-50 SSR	-75 SSR	-100 SSR
Voltage range (ACrms)	48-660	48-660	48-660
Max current @ 40°C	55	75	100
Off-state leakage @ max voltage	5mA	5mA	5mA
Max 1 cycle surge current (Apk @ 25°C)	1200	1000	1200
Max 1 sec. surge current (Apk @ 25°C)	350	280	350

### Input

	4-32Vdc	90-280Vrms
Control Voltage	4-32Vdc	90-280Vrms
Dropout Voltage	1Vdc	10Vrms
Max input current	14mA	10mArms
Min on state current	7mA	6mArms
Input Resistance	Current Regulated	

### Fan Information

Part Number	99 484 451
Control Voltage	10.2 – 13.8 Vdc
Current	0.19 amps
Airflow	22 CFM
Operating Temperature	-10 to +72°C
Leads	UL 24AWG, + Red, - Black
Life Expectancy	70,000 hrs @ 25°C, 40,000 hrs @ 55°C, 25,000 hrs @ 65°C

**DERATE CURVES:  
55A GN SSR ON HS-10 (-50)**

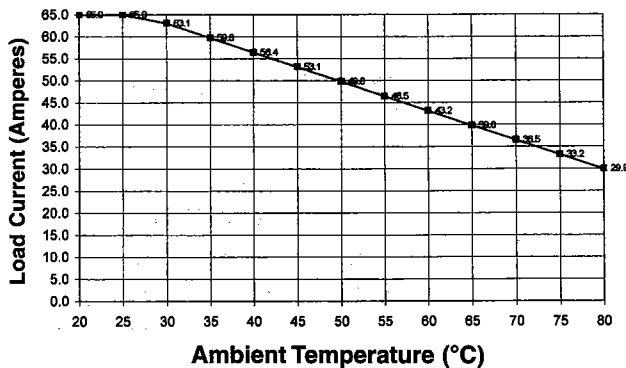

**DERATE CURVES:  
75A GN SSR ON HS-12 (-75)**

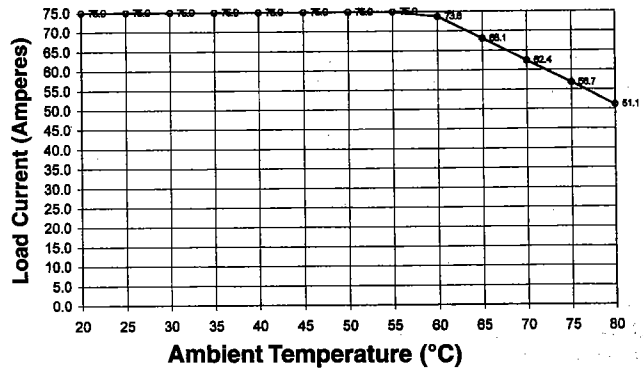

**DERATE CURVES:  
100A GN SSR ON HS-12 (-100)**

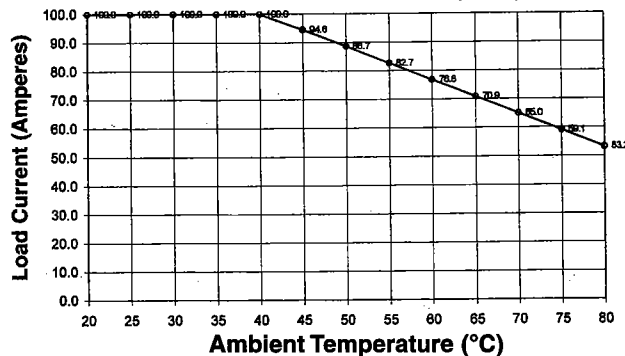

Products and specifications subject to change without notice.  
Consult factory for application assistance.